

# Industrial Recorders $\mu$ R10000/ $\mu$ R20000



# $\mu$ R

## Intelligent Industrial Recorders

The  $\mu$ R series are the compact industrial recorders with the recording widths of 100 mm and 180 mm.

The 100 mm family consists of 1,2,3,4-pen and 6-dot models.

The 180 mm family consists of 1,2,3,4-pen and 6,12,18,24-dot models.

Bulletin 04P02B01-01E

[www.yokogawa.com/ns/](http://www.yokogawa.com/ns/)

A Yokogawa Commitment to Industry

**vigilance**<sup>®</sup>

**YOKOGAWA** 



# YOKOGAWA INDUSTRIAL RECORDERS

Get reliable, high quality output with the "Power of Paper!"  
Recorders with the reliability of Yokogawa

## $\mu$ R100000™ $\mu$ R200000™

The Information You Need:  
Easier to Acquire, Easier to Read

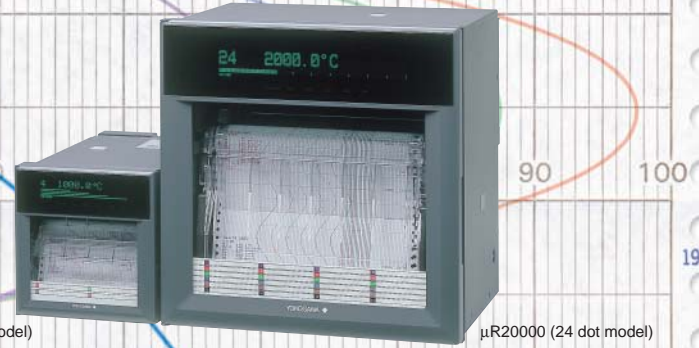

### Leading-Edge Technology Offers High Reliability and High Quality

- Leveraging contact-less technology
- Actuators reduced in size through high precision manufacturing technology
- High degree of integration using custom ICs
- Dust and splashproof front door (conforms to IP54)

Servo Unit



High-Voltage Solid-State Scanner

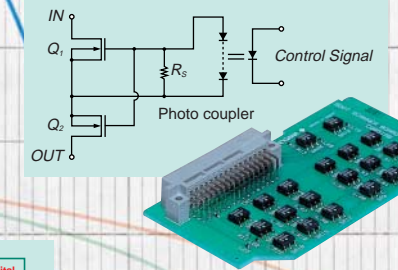

ASIC

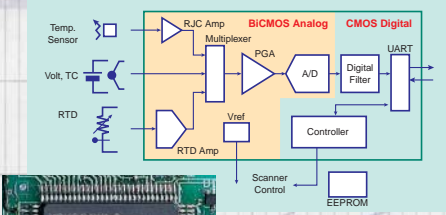

Splash-proof Front Door



### Superior Ease-of-Operation

- Large, VFD full dot matrix display (μR10000: 101 x 16, μR20000: 181 x 16)
- Easily navigable interactive settings
- New chart cassette (enables historical trend review during recording)
- Internal illumination comes standard (high intensity white LED)



### Multiple Functions Meet a Variety of Needs

- Broad lineup (1-, 2-, 3-, or 4-pen models, and 6-, 12-, 18-, or 24-dot models)
- Dot model (6-dot model) achieves one second measurement intervals
- Universal input
- Supports a wide range of input sensors
- Supports 35 types of input including optional TC, RTD.
- Mathematical functions
- No. of Mathematical channels: 8 channels (Pen models), 12 channels (μR10000 dot model), 24 channels (μR20000 dot models)
- Computation types: Arithmetic, logic, relation and static computations
- Recording: Pen model: Assignable to any pen, Dot model: Fully recordable
- Supports Ethernet or RS-422A/485 interfaces



# Delivers Confidence

The critical factor in continuous recording using industrial recorders is reliability. Leveraging the latest technology, Yokogawa brings you that reliability in a compact, lightweight unit that embodies all the breakthroughs and know-how that Yokogawa has cultivated over the years.

## Bringing You the Highest Reliability

### Servo Unit

The pen servo unit takes advantage of an ultra-small, rack-and-pinion stepping motor. The servo unit is smaller and consumes less power than previous models.

### Splash-proof Front Door

(conforms to DIN 40050-IP54)  
The front door meets DIN 40050-IP54 standards in panel-mount installations.

### Safety/EMC Standards

Yokogawa's highly reliable industrial recorders support safety and EMC (electromagnetic compatibility) standards. And of course, the µR conforms to the European CE marking standard.



6 dot model



### Optional Terminals\*

\* Individual terminals are removable, making wiring and maintenance easy.

### Input Terminals\*

### Ethernet (10Base-T)

Data management possible via network.

### Lightweight

Innovative molding technology reduces the number of parts and lowers the weight of the unit. Higher efficiency and low heat emissions have also been achieved through a high degree of integration and a new type of servo unit.



(EMI testing LAB in Yokogawa)

### High-Voltage Solid State Scanners

High withstand voltage semiconductor relays have been adopted for scanners that switch the input signal. They enable high speed scanning of six dots per second, increase the life of the scanner, and reduce noise.

### Use of ASICs

The recorders feature a high degree of functional integration through Yokogawa's renowned ASICs (application specific integrated circuits, or custom ICs). They allow for reduced power consumption, increased lifespan of components, and suppressing of heat emissions.

## Matching the Displayed Operation Screen to the Application

The user can switch between up to fifteen previously configured operation screens using the DISP key.



## Multi-Display (Displays a Variety of Screens) for Site Monitoring

Displays that support our customers' site monitoring needs with high visibility. Large VFD: 101 x 16 full dot matrix using a variety of screens.

### "I want to use my recorder as a monitor."

6 channel digital display (6 dot model)



2 channel digital display



### "I want to monitor the recorder position on an analog indicator."

Flag display



### "I want to monitor alarms collectively."

Channel alarm status display



## Navigational Display Makes Setup a Snap

The instrument features a simple configuration, with Operation mode for normal use, and Setting mode for use during setup. In Operation mode, measured values, time, and alarms are updated, and lists are printed. In

Setting mode, you can enter measuring ranges, alarm values, and other parameters. Also, Setting mode offers a navigational display that eases entry of settings.



Navigational display to support setting selections. (Example: Range Setting)

## Easier to Acquire, Easier to Read

Uses a large, easy-to-view VFD 101 x 16 full dot matrix display. All settings are interactive, and supported by the navigational display, offering easier to read selections and superior ease of operation.



# Delivers Confidence

The critical factor in continuous recording using industrial recorders is reliability. Leveraging the latest technology, Yokogawa brings you that reliability in a compact, lightweight unit that embodies all the breakthroughs and know-how that Yokogawa has cultivated over the years.

INTELLIGENT INDUSTRIAL RECORDERS



## Bringing You the Highest Reliability

### Servo Unit

The pen servo unit takes advantage of an ultra-small, rack-and-pinion stepping motor. The servo unit is smaller and consumes less power than previous models.

### Splash-proof Front Door

(conforms to DIN 40050-IP54)  
The front door meets DIN 40050-IP54 standards in panel-mount installations.

### High-Voltage Solid State Scanners

High withstand voltage semiconductor relays have been adopted for scanners that switch the input signal. They enable high speed scanning of six dots per second or twelve to twenty-four dots in 2.5 seconds, increase the life of the scanner, and reduce noise.

### Use of ASICs

The recorders feature a high degree of functional integration through Yokogawa's renowned ASICs (application specific integrated circuits, or custom ICs). They allow for reduced power consumption, increased lifespan of components, and suppressing of heat emissions.

### Safety/EMC Standards

Yokogawa's highly reliable industrial recorders support safety and EMC (electromagnetic compatibility) standards. And of course, the µR conforms to the European CE marking standard.

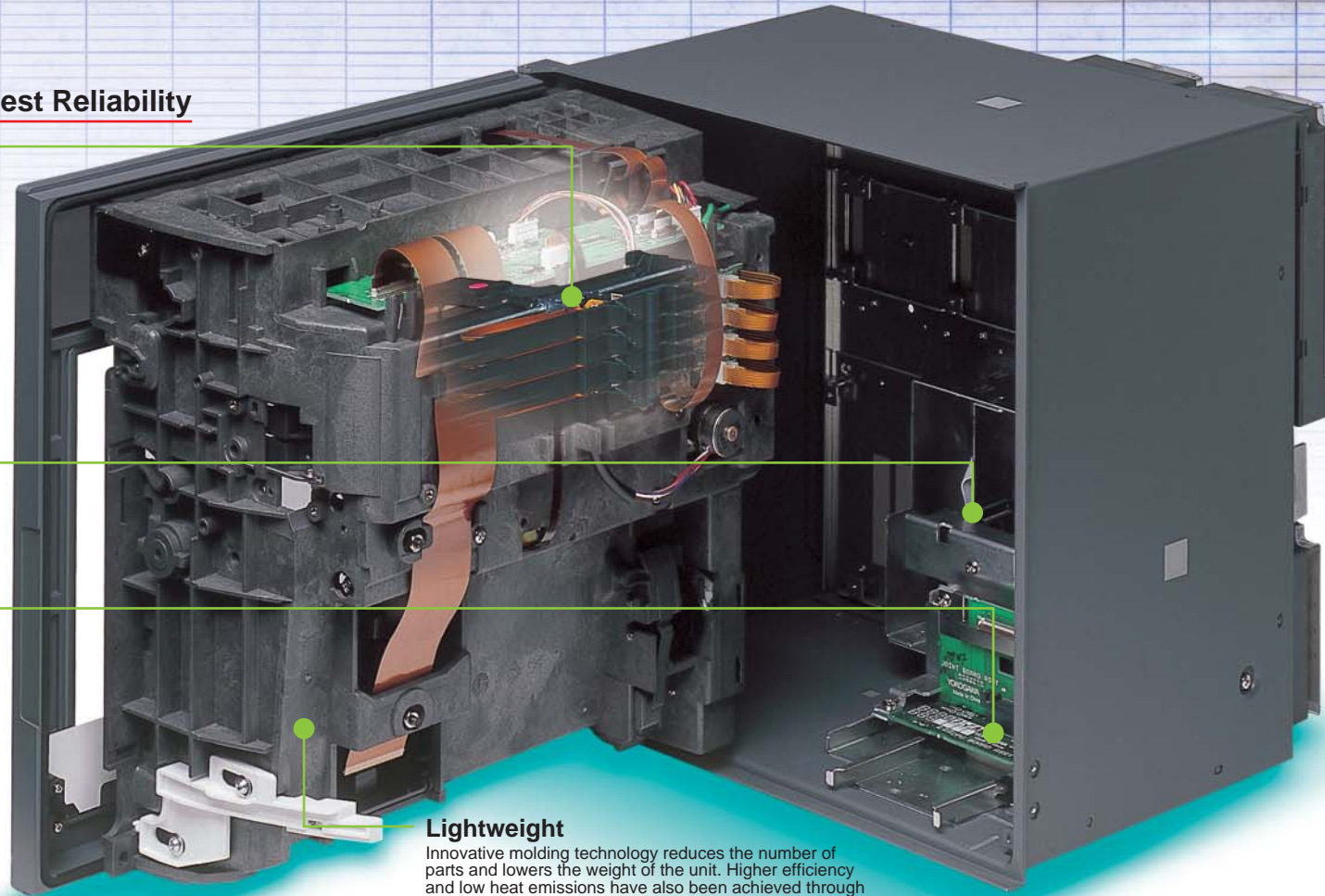

### Lightweight

Innovative molding technology reduces the number of parts and lowers the weight of the unit. Higher efficiency and low heat emissions have also been achieved through a high degree of integration and a new type of servo unit.

## Multi-Display (Displays a Variety of Screens) for Site Monitoring

Displays that support our customers' site monitoring needs with high visibility. Large VFD: 181 x 16 full dot matrix using a variety of screens.

- "I want to use my recorder as a monitor."  
12 channel digital display (12, 18, and 24 dot models)

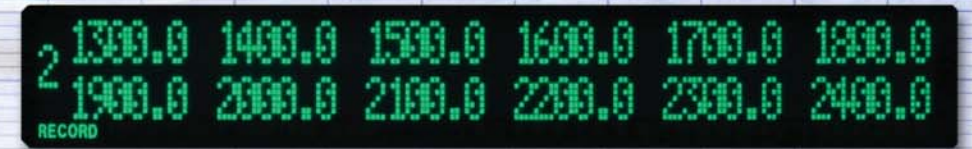

Two groups are alternately displayed: 18 dot model 1Gr (1 to 12ch), 2Gr (13 to 18ch)  
24 dot model 1Gr (1 to 12ch), 2Gr (13 to 24ch)

4 channel digital display



- "I want to monitor the recorder position on an analog indicator."  
Flag display



- "I want to monitor alarms collectively."  
Channel alarm status display



## Matching the Displayed Operation Screen to the Application

The user can switch between up to fifteen previously configured operation screens using the DISP key.



### Optional Terminals\*

\* Individual terminals are removable, making wiring and maintenance easy.

### Input Terminals\*

**Ethernet (10Base-T)**  
Data management possible via network.

## Navigational Display Makes Setup a Snap

The instrument features a simple configuration, with Operation mode for normal use, and Setting mode for use during setup. In Operation mode, measured values, time, and alarms are updated, and lists are printed. In Setting mode, you can enter

measuring ranges, alarm values, and other parameters. Also, Setting mode offers a navigational display that eases entry of settings.

Navigational display to support setting selections (Example: Range Setting)



## Easier to Acquire, Easier to Use

Uses a large, easy-to-view VFD 181 x 16 full dot matrix display. All settings are interactive, and supported by the navigational display, offering easier to read selections and superior ease of operation.



# Broad Functionality for Wide Range of Applications

The instrument comes with a full set of functions to cover the many needs of our customers and support their applications.

## Variety of Networking Functions

### Ethernet Support

By using DAQLOGGER with the DX, DARWIN, or other instruments on your existing network, you can manage measured data centrally. (GateμR software required for the μR, sold separately). Also, using DAQLOGGER's event processor, you can automatically send information when Event/Report data occurs (alarms, time, file creation, etc.) via e-mail or FTP.

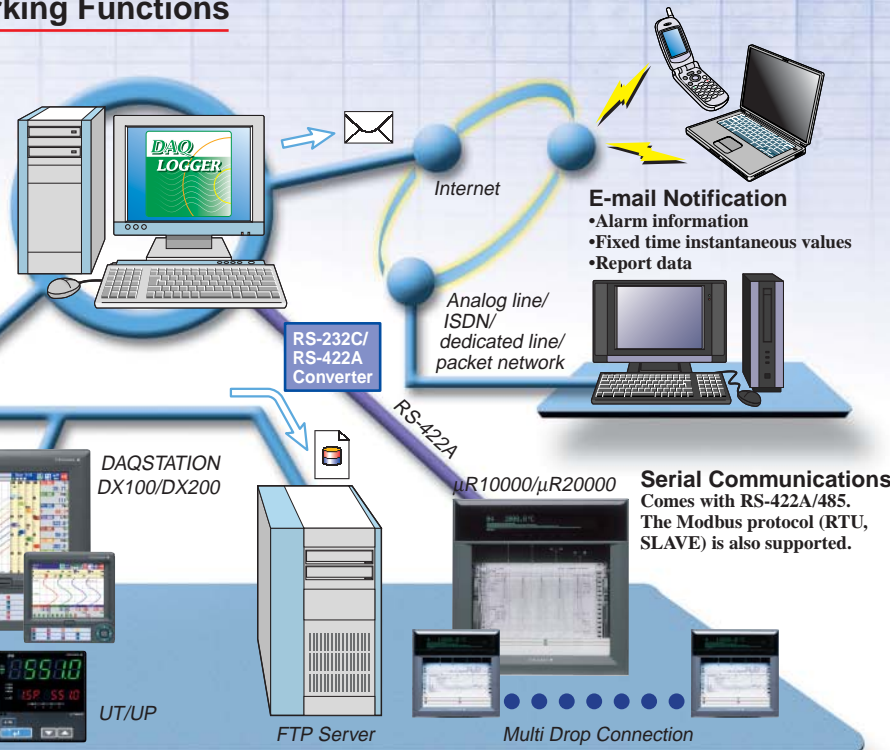

**E-mail Notification**  
 • Alarm information  
 • Fixed time instantaneous values  
 • Report data

**Serial Communications**  
 Comes with RS-422A/485. The Modbus protocol (RTU, SLAVE) is also supported.

## A Wealth of Recording and Printing Functions

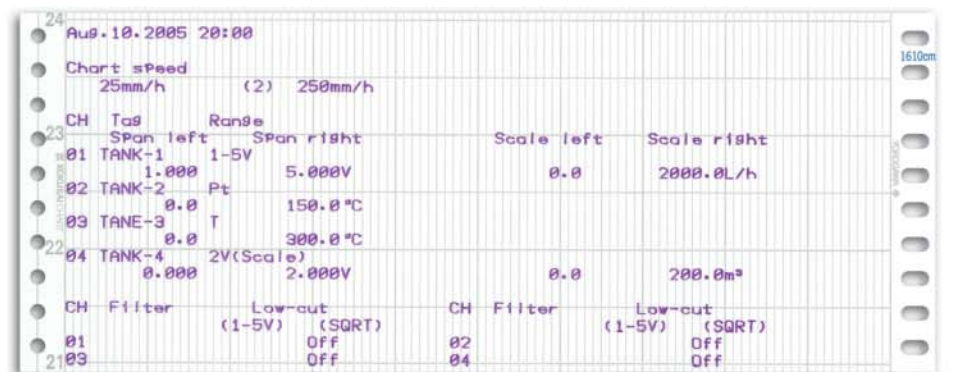
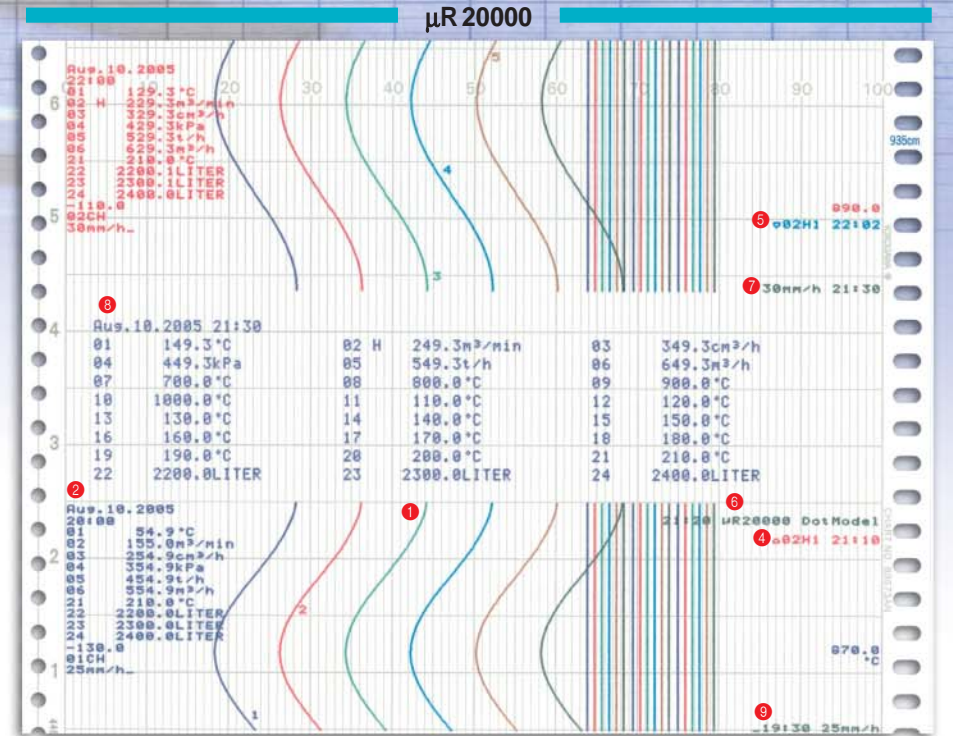
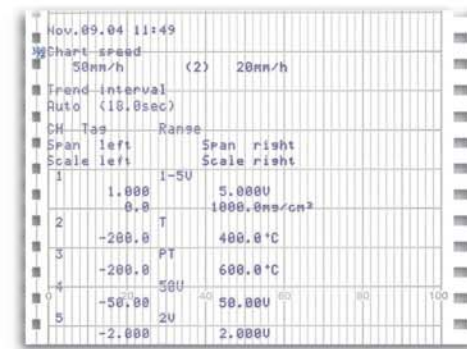
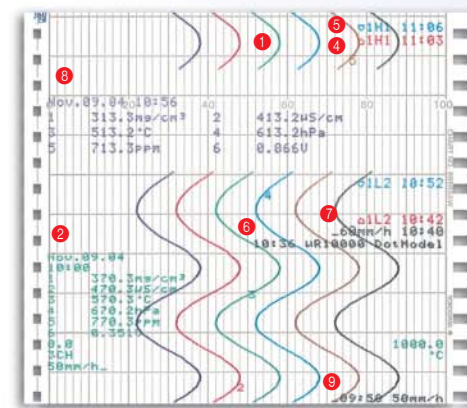
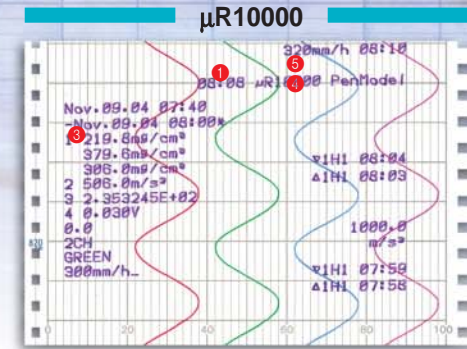

## Application Software That Expands the Possibilities of the μR

### DAQLOGGER Highly Reliable Data Logging Software

DAQLOGGER lets you build a realtime data logging environment with up to thirty two of our main recorders, data acquisition instruments, and controllers, on up to sixteen hundred channels.

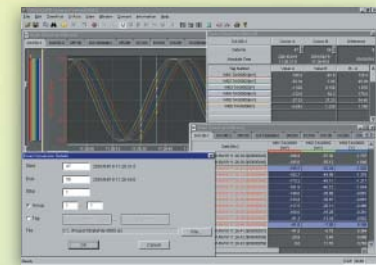
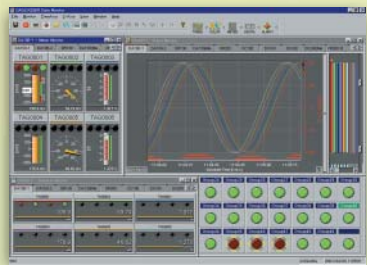

### Monitor Software

Displays measured and computed data on the PC screen in real time. Enables construction of an optimal monitoring environment.



### Viewer Software

Lets you easily redisplay, analyze, and convert logged data, and print waveforms.

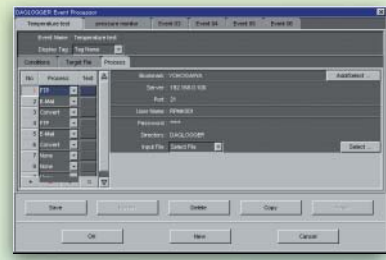

### E-mail Transmission

Sends e-mail messages upon occurrence of events. You can also attach data, reports, instantaneous values, or monitor screens to e-mails.

### FTP Client Function

You can have data files and reports automatically sent by FTP to a file server when they are created.

### RXA10 Configuration Software (sold separately)

Entry and management of settings for measurement and calculation channels is easier than ever. Also, settings can be entered via communication interface.

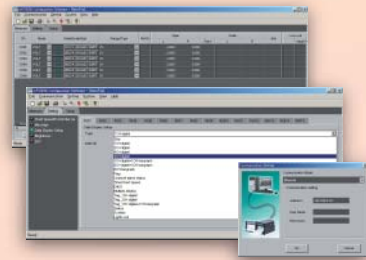

- 1 Analog recording
- 2 Periodic printouts\*
- 3 Report printout\*
- 4 Alarm printouts (occurring)
- 5 Alarm printouts (cleared)
- 6 Message printouts
- 7 Chart speed change printout
- 8 Manual printout
- 9 Chart start time printout

\*: In Set mode, you can select periodic printout, report printout, or "None." Select from the following report printout contents: AVE (average) by channel only, MIN (minimum) only, MAX (maximum) only, MIN/MAX/AVE, SUM, or INST (instantaneous value).

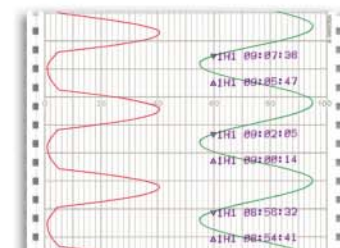

**Partial expanded recording**  
 Any important portion within the full scale can be expanded for recording.

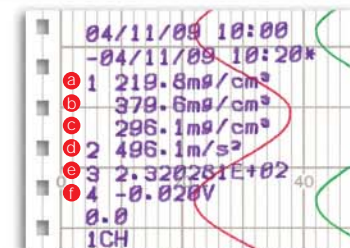

- 1 MIN
- 2 MAX
- 3 AVE
- 4 SUM
- 5 INST

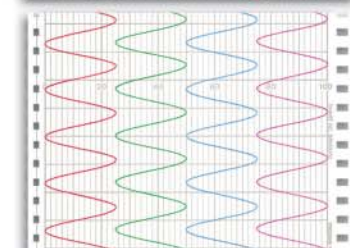

**Zone recording**  
 Recording areas (zones) for each channel can be recorded separately.



# A Surprising Variety of Applications and Uses to Meet Every Customer's Needs.

INTELLIGENT INDUSTRIAL RECORDERS

# μR SERIES

# Specifications

See the general specification (GS04P01B01-01E, GS04P02B01-01E) for the detailed specifications.

## Data Display and Recording for Water Purification Equipment (Acquisition of Data on Water Quality/Amount of Flow)

Environmental data (water quality, amount of flow) is measured on-site and monitored from an office.

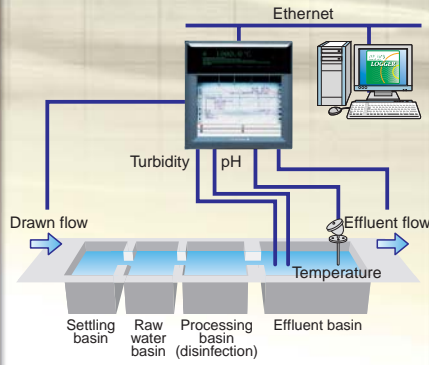

- Display and record temperature, flow, turbidity, pH, dissolved oxygen, and other factors, and monitor on-site.
- Automatic calculation of flow with the computation function (M1 option).
- Connect with DAQLOGGER for remote monitoring in real time

## Temperature Monitoring and Recording in a Tunnel Kiln (Acquisition of Temperature Data for Ceramic Processing)

Select screens and display intervals according to on-site processes (zones) to create the optimum temperature monitoring and recording setup.

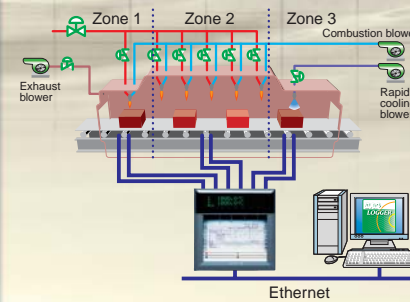

- Select from a variety of inputs (universal input)
- Monitor and record alarms on site upon occurrence of temperature data and abnormalities.
- Optimized monitoring through simultaneous display of multiple channels and AUTO screen switching
- Connect DAQLOGGER to control the operational conditions (temperature and alarms) in a furnace from your office.

## Managing Sterilization of Pharmaceuticals and Foodstuffs (Acquisition of Sterilization/Pasteurization Data)

MATH function (M1 option) enables recording (and F value calculation) of sterilization and pasteurization processes.

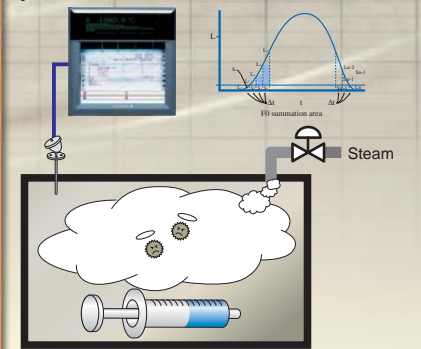

- Automatically computes F0 value according to temperature
- Computed results are recorded together with temperature and other parameters (pharmaceutical/foodstuff temperature, pressure, etc.)
- Measurement ON/OFF through external contact input (R1 option)

- Select from a variety of inputs (universal input)
- Automatically computes relative humidity from dry bulb temperature and wet bulb temperature (M1 option)
- Computed results are recorded together with temperature and humidity (pressure and current)

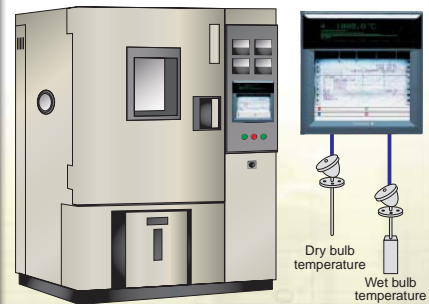

Measures environmental testing data, and displays and records a variety of data in an easy-to-understand format

## Display and Recording of Data from Environmental Testing Equipment (Acquisition of Test data from a Thermostatic Chamber)

- Select from a variety of inputs such as Cu input sensors (N1 option)
- Monitor and record alarms upon occurrence of temperature, vibration, and abnormalities.
- Connect with DAQLOGGER for data acquisition and analysis when abnormalities occur

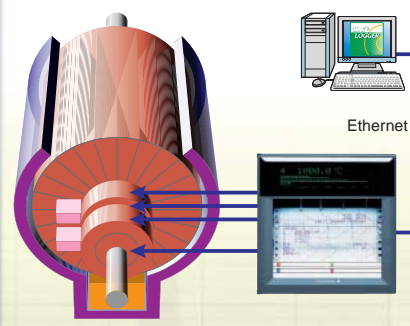

Measures temperature and vibration of the turbine for rapid identification of abnormalities

## Equipment Maintenance in a Power Plant (Acquisition of Data on Turbine Temperature and Vibration)

- Select from a variety of inputs (universal input)
- Displays temperature and wire diameter simultaneously for monitoring of correlations
- Monitor and record diameter, temperature, and alarms upon occurrence of abnormalities on site.

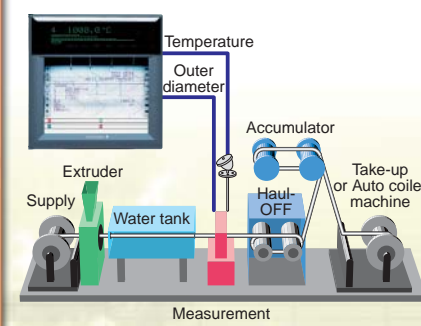

Displays outer diameter and temperature in a electrical wire coating process for monitoring insulation quality

## Management of Electrical Wire Coating Process (Acquisition of Data on Wire Temperature and Outer Diameter)

### Input

- **Measurement Inputs**  
μR10000: 1, 2, 3, 4 (pen) and 6 (dot) points  
μR20000: 1, 2, 3, 4 (pen) and 6, 12, 18, 24 (dot) points
- **Inputs**  
Universal input  
DCV: 20, 60, 200 mV, 2, 6, 20, 50 V, 1-5 V  
TC: R, S, B, K, E, J, T, N, W, L, U, WRε  
RTD: Pt100, JPt100  
DI: Digital Input (contact or DC Voltage, TTL level).  
DCA: Direct Current Input (using external shunt resistor (10 Ω, 100 Ω, 250 Ω))
- **Measurement Interval**  
Pen model...125 ms/channel  
Dot model...μR10000: 1 s/6 dot or 2.5 s/6 dot  
μR20000: 1 s/6 dot, 2.5 s/12 to 24 dot or 2.5 s/6 dot, 5 s/12 dot, 10 s/18 to 24 dot
- **Burnout**  
Available on TC and 1-5 VDC range  
ON/OFF selectable (per channel)  
1-5V Burnout: less than 0.2V
- **Filter**  
Pen model: Signal damping  
ON/OFF selectable (per channel), Time constant (2, 5, 10sec)  
Dot model: Moving average  
ON/OFF selectable (per channel), Moving average cycle (2 to 16)
- **Standard Computation**  
Differential computation, Linear scaling, Square root, Bias addition

### Recording and Printing

- **Recording Method**  
Pen model: Disposable felt pens, Plotter pen  
Dot model: 6 color wire dot
- **Pen Offset Compensation:**  
ON / OFF selectable (Pen model only)
- **Effective Recording Width**  
μR10000: 100 mm  
μR20000: 180 mm
- **Chart**  
μR10000: Plain-paper Z-fold chart (16 m)  
μR20000: Plain-paper Z-fold chart (20 m)
- **Recording Period**  
Pen model: Continuous for each channel  
Dot model: μR10000; Max. 6 ch/10sec  
μR20000; Max. 6 ch/10 s, 7 to 12 ch/15 s, 13 to 18 ch/20 s, 19 to 24/30 s
- **Chart Speed**  
Pen model: 5 to 12000 mm/h (82 increments)  
Dot model: 1 to 1500 mm/h (1 mm step)
- **Chart Speed Change**  
speed 1, speed 2 change by remote control signals (option).
- **Recording Colors**  
Pen model: pen1=red, pen2=green, pen3=blue, pen4=violet, plotter pen=purple  
Dot model: μR10000  
ch1=purple, ch2=red, ch3=green, ch4=blue, ch5=brown, ch6=black (color can be assigned to any channel)  
μR20000  
ch1, 7, 13, 19=purple ch2, 8, 14, 20=red ch3, 9, 15, 21=green ch4, 10, 16, 22=blue ch5, 11, 17, 23=brown ch6, 12, 18, 24=black (color can be assigned to any channel)
- **Recording Format**  
Analog recording: Zone recording, Partial expanded recording  
Digital printout: Channel number or TAG (Dot model only), Alarm, Periodic printout or Report printout, Message printout, Record start time, Chart speed printout, List printout, Manual printout, SET UP List printout

### Display

- **Display Method**  
μR10000: VFD (101×16 dot matrix)  
μR20000: VFD (181×16 dot matrix)
- **Display Types**  
Multiple displays  
Digital, bar, flag, DI/DO display etc. can be displayed.  
15 display types can be selected from approx. 80 display types.
- **Status Display**  
Recording in progress (RECORD), Shared alarm (ALARM), Channel No. display of occurring alarm (pen model: 1 2 3 4 or Dot model: μR10000: 1 to 6, μR20000: 1 to 24), Chart end display (CHART END) For the model with option (FAIL/chart end detection and output), Math (MATH), Key lock display (KEY LOCK)
- **Setting**  
Settings display by interactive mode. In setting, navigator method is used. Display updated interval can be selected from AUTO/MAN.
- **Bar Graph Display**  
Measurement value: left/right (%) reference or center zero reference display (each channel selectable).  
Alarm: Alarm setting level display and flashing display of occurring alarm.
- **Display Brightness Setting**  
Display brightness level: 1 to 8

### Alarm

- **Number of Levels**  
Up to 4 level for each channel.
- **Alarm Type**  
High and low limits, differential high and low limits, high and low rate-of-change limits and delay high and low Interval time of rate-of-change alarms: The measurement interval times 1 to 15
- **Display**  
Set value is indicated as a point on the bar graph (only for bar graph display)  
In case of an alarm:  
- For digital display: Alarm type indicator  
- Shared alarm display  
- Alarm occurring channel No. is displayed  
- For bar graph display: Flashing point indicator

### Power supply

- **Rated Power Voltage**  
100-240 VAC (automatically selected)
- **Power Voltage Range**  
90-132 VAC, 180-264 VAC
- **Rated Power Frequency**  
50 Hz/60 Hz (automatically selected)
- **Power Consumption**  
μR10000 (Approx.)

	100 VAC power source	240 VAC power source	Maximum
1 to 4 pen model	12 VA*	17 VA*	40 VA*
6 dot model	13 VA*	18 VA*	40 VA*

\* In balance

	100 VAC power source	240 VAC power source	Maximum
1 to 4 pen model	17 VA*	25 VA*	55 VA*
6 to 24 dot model	17 VA*	23 VA*	55 VA*

\* In balance

### General Specification

- **Ambient Temperature and Humidity**  
0 to 50°C, 20 -80%RH (at 5 to 40°C)
- **Memory Backup**  
Lithium battery to save settings parameters  
Approx. 10 years (at room temperature, for standard model)
- **Settings Protection Function**  
Password method
- **Internal Light**  
White LED
- **Operation Position**  
0° Frontwards: Within 30° from horizontal

### Optional Specification

- **Alarm output relay (A1, A2, A3, A4\*, A5\*)**  
Number of output: 2, 4, 6, 12\*, 14\*  
Relay contact rating: 250 VDC/0.1 A (resistance load), 250 VAC (50/60 Hz) /3 A  
\*only for μR20000
- **RS-422A/485 communication interface (C3)**  
Measurement value output and setting parameter input/output  
Conforms to EIA-422A (RS-422A) and EIA-485 (RS-485) standard
- **Ethernet communication interface (C7)**  
Measurement value output and setting parameter input/output  
Transmission media: 10 Base-T  
Protocol: TCP, IP, UDP, ICMP, ARP
- **FAIL/chart end detection and output (F1)**  
In CPU error occurrence or the chart end, output relay is activated.  
Relay contact rating: 250 VDC/0.1 A (resistance load), 250 VAC (50/60 Hz) /3 A
- **Clamped input terminal (H2)**  
Clamped input
- **Non-glare door glass (H3)**  
Non-glare door glass for front door
- **Mathematical function (M1)**  
Number of computation channel: 8 channels (pen model), 12 channels (μR10000 dot model), 24 channels (μR20000 dot model)  
Arithmetic operation (+, -, ×, ÷), Square, Absolute, Common logarithm (y=log10x), Exponential (eX), Power (Xn), Relational operator (<, ≤, ≥, =, ≠), Logic (AND, OR, NOT, XOR)  
Statistical computation: Statistical type: MAX, MIN, AVE, SUM, MAX-MIN  
Computation channel can be recorded
- **Cu10, Cu25 RTD input (N1)**  
Cu10, Cu25 RTD input  
Pt100 and JPt100 inputs can be used together.
- **3 legs isolated RTD input (N2)**  
A, B, b legs of RTD are isolated for dot model
- **Expansion inputs (N3)**  
Following input types can be supported besides standard inputs.  
TC: PR40-20, PLATINEL, NiNiMo, W/WRe26, Type N (AWG14), Kp vs Au7Fe  
RTD: Pt25, Pt50, Ni100 (SAMA), Ni100 (DIN), Ni120, J263\*B, Cu53, Cu100  
\*Cu100: α=0.00425 at 0°C
- **Remote control (R1)**  
Below actions can be assigned to up to 5 points  
Recording start/stop, Chart speed change, Message printout start, Manual printout start, Alarm ACK, Time set, Math start/stop, Math reset

● Superior ease-of-operation

● Easy-to-see display

● Accurate measurement

● Reliable recording

Supports our customers' site monitoring needs.

Offers optimal solutions and a user-friendly operating environment.



## Model Codes

### μR10000

Model Code	Suffix Code	Option Code	Description
436101			μR10000 1 pen recorder
436102			μR10000 2 pen recorder
436103			μR10000 3 pen recorder
436104			μR10000 4 pen recorder
436106			μR10000 6 dot recorder
Language	-2		English
Option		/A1	Alarm output relay (2 contacts) <sup>1</sup>
		/A2	Alarm output relay (4 contacts) <sup>1</sup>
		/A3	Alarm output relay (6 contacts) <sup>1,2</sup>
		/C3	RS-422A/485 communication interface <sup>3</sup>
		/C7	Ethernet communication interface <sup>3</sup>
		/F1	FAIL/chart end detection and output <sup>2</sup>
		/H2	Clamped input terminal <sup>4</sup>
		/H3	Non-glare door glass
		/M1	Mathematical function
		/N1	Cu10, Cu25 inputs
		/N2	3 legs Isolated RTD <sup>4,5</sup>
		/N3	Expansion inputs <sup>6</sup>
		/R1	Remote control (5 contacts)

- 1: Only one of /A1, /A2, /A3 can be selected  
 2: /A3 and /F1 can not be specified together  
 3: /C3 and /C7 can not be specified together  
 4: /H2 and /N2 can not be specified together  
 5: /N2 can be specified only for dot model  
 6: 14 types inputs: Pt50 RTD, PR40-20, PLTINEL TC etc.

### μR 20000

Model Code	Suffix Code	Option Code	Description
437101			μR20000 1 pen recorder
437102			μR20000 2 pen recorder
437103			μR20000 3 pen recorder
437104			μR20000 4 pen recorder
437106			μR20000 6 dot recorder
437112			μR20000 12 dot recorder
437118			μR20000 18 dot recorder
437124			μR20000 24 dot recorder
Language	-2		English
Option		/A1	Alarm output relay (2 contacts) <sup>1</sup>
		/A2	Alarm output relay (4 contacts) <sup>1</sup>
		/A3	Alarm output relay (6 contacts) <sup>1</sup>
		/A4	Alarm output relay (12 contacts) <sup>1,2</sup>
		/A5	Alarm output relay (24 contacts) <sup>1,3,4</sup>
		/C3	RS-422A/485 communication interface <sup>5</sup>
		/C7	Ethernet communication interface <sup>5</sup>
		/F1	FAIL / Chart end detection and output <sup>2,3</sup>
		/H2	Clamped input terminal <sup>6</sup>
		/H3	Non-glare door glass
		/M1	Mathematical function
		/N1	Cu10, Cu25 RTD input
		/N2	3 legs isolated RTD input <sup>6,7</sup>
		/N3	Expansion inputs <sup>8</sup>
		/R1	Remote controls (5 contacts)

- 1: only one of /A1, /A2, /A3, /A4, /A5 can be selected  
 2: /A4 and /F1 can not be specified together for pen model  
 3: /A5 and /F1 can not be specified together  
 4: /A5 can be specified only for dot model  
 5: /C3 and /C7 can not be specified together  
 6: /H2 and /N2 can not be specified together  
 7: /N2 can be specified only for dot model  
 8: 14 types inputs: Pt50 RTD, PR40-20, PLTINEL TC etc.

Model Code	Description	OS
RXA10-01	RXA10 configuration software*	Windows 2000/XP
RXA10-02	RXA10 configuration software* (With interface unit)	Windows 2000/XP

\* The support of μR20000 is a phase plan.

## Standard Accessories

Name	1 pen	2 pen	3 pen	4 pen	dot	
Z-fold chart	1	1	1	1	1	
6 color ribbon cassette	-	-	-	-	1	
Disposable felt-pen cartridge	Red	1	1	1	-	
	Green	-	1	1	-	
	Blue	-	-	1	1	-
	Violet	-	-	-	1	-
Plotter pen	1	1	1	1	-	
Mounting brackets	2	2	2	2	2	
Instruction manual (CD-ROM)	1	1	1	1	1	
Operation manual	1	1	1	1	1	

## Spares/Optional Accessories

Name	Model Code (Parts No.)	Specification
Z-fold chart	for μR10000 B9565AW for μR20000 B9573AN	10 (sales unit)
6 color ribbon cassette	for μR10000 B9901AX for μR20000 B9906JA	1 (sales unit)
Disposable felt-pen cartridge	Red B9902AM	1 (sales unit, 3 piece/unit)
	Green B9902AN	1 (sales unit, 3 piece/unit)
	Blue B9902AP	1 (sales unit, 3 piece/unit)
	Violet B9902AQ	1 (sales unit, 3 piece/unit)
Plotter pen	Purple B9902AR	1 (sales unit, 3 piece/unit)
Mounting brackets	B9900BX	2 (sales unit)
Shunt resistor (for screw input terminal)	415920	250 Ω ± 0.1%
	415921	100 Ω ± 0.1%
	415922	10 Ω ± 0.1%
Shunt resistor (for clamped input terminal)	438920	250 Ω ± 0.1%
	438921	100 Ω ± 0.1%
	438922	10 Ω ± 0.1%

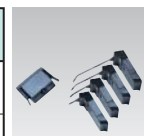

Disposable felt-pen, Plotter pen



6 color ribbon cassette

## Dimensions

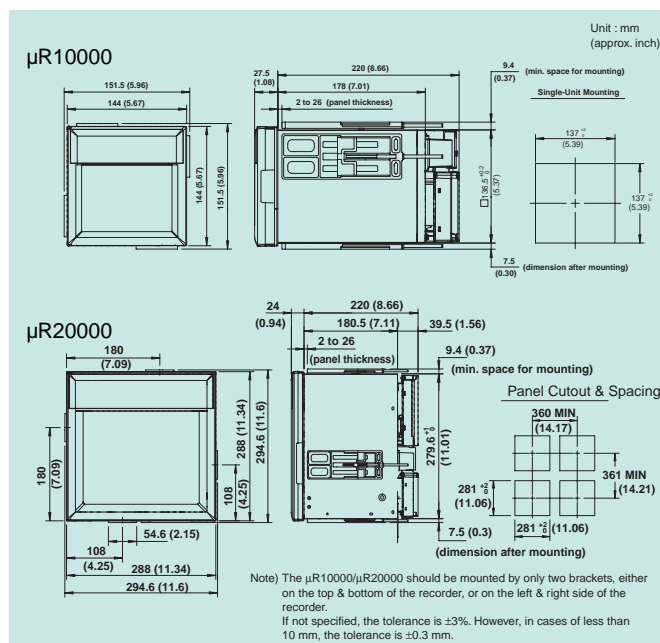

### NOTICE

- Before operating the product, read the instruction manual thoroughly for proper and safe operation.
- If this product is for use with a system requiring safeguards that directly involve personnel safety, please contact the Yokogawa sales offices.

# YOKOGAWA

YOKOGAWA ELECTRIC CORPORATION  
 Network Solutions Business Div./Phone: (81)-422-52-7179, Fax: (81)-422-52-6793  
 E-mail: ns@cs.jp.yokogawa.com

YOKOGAWA CORPORATION OF AMERICA  
 YOKOGAWA EUROPE B.V.  
 YOKOGAWA ENGINEERING ASIA PTE. LTD.

Phone: (1)-770-253-7000, Fax: (1)-770-251-2088  
 Phone: (31)-33-4641806, Fax: (31)-33-4641807  
 Phone: (65)-62419933, Fax: (65)-62412606

Subject to change without notice.  
 [Ed : 01/b] Copyright ©2005  
 Printed in Japan, 508(KP)